

INSTALLATION INSTRUCTIONS

Item#N6775-293 (New. 04/24/2017)

READ AND SAVE THESE INSTRUCTIONS

WARNING! SHUT POWER OFF AT FUSE OR CIRCUIT BREAKER.

AVERTISSEMENT! COUPER LE COURANT AU NIVEAU DES FUSIBLES OU DU DISJONCTEUR.

PREPARATION (Fig. 1)

1. Shut off the power at the fuse box or circuit breaker. If necessary, remove the old fixture, including the mounting hardware.
2. Carefully remove the fixture from the carton and check that all parts are included as shown in the illustration.

ASSEMBLING THE FIXTURE WITH CHAIN LOOP (Fig. 2)

3. Determine the desired hanging height and thread rods (F1, F2 and F3) to the nipple (I) of the fixture body (L). Then attach loop (H1) by screwing in to rod (F1). Note: remove the nipple if installing with one 6" rod only.
4. Attach the quick link (G) connect to loop (H1) and loop (H2) on the canopy (D), carefully feed the wire over loop (H1), quick link (G) and loop (H2).
5. Thread screws (A) into the pre-drilled holes in the circular strap (B) spaced the same distance apart as the holes in the canopy (D).
6. Attach the circular strap (B) to the Junction box using mounting screws (C) (Size: #8-32N*L0.5"). The side of the circular strap marked "GND" must face out.
7. The support cable is provided to support the weight of the fixture while wiring. Align the fixture to circular strap (B) and attach hook (P) on the end of support cable (N) into a slot located on circular strap (B). Carefully allow the support cable (N) to support the weight of the fixture while wiring.

CONNECTING THE WIRES (Fig. 3)

8. At this point, connect the electrical wires as shown in figure 3, making sure that all wire connectors are secured. If your outlet has a ground wire (green or bare copper), connect the fixture's ground wire to it. Otherwise, connect the fixture's ground wire directly to the circular strap using the green screw provided.
9. Tuck the wire connectors neatly into the ceiling Junction Box and then raise the canopy all the way to the ceiling.

COMPLETING THE INSTALLATION (Fig. 1)

10. Thread canopy (D) into screws (A), and secure with knurled knobs (E).
11. Place the candle cover (K) over the socket (M) of the fixture body (L).
12. Install light bulb(s) (J) in accordance with the fixture's specification. **(DO NOT EXCEED THE MAXIMUM WATTAGE RATING!) (NE PAS DEPASSER LA PUISSANCE NOMINALE MAXIMALE!).**

Your installation is now complete. Return power to the junction box and test the fixture.

Note: Illustration (Fig. 1) on this manual is for installation purposes only. It may or may not be identical to the fixture purchased.

Fig. 1

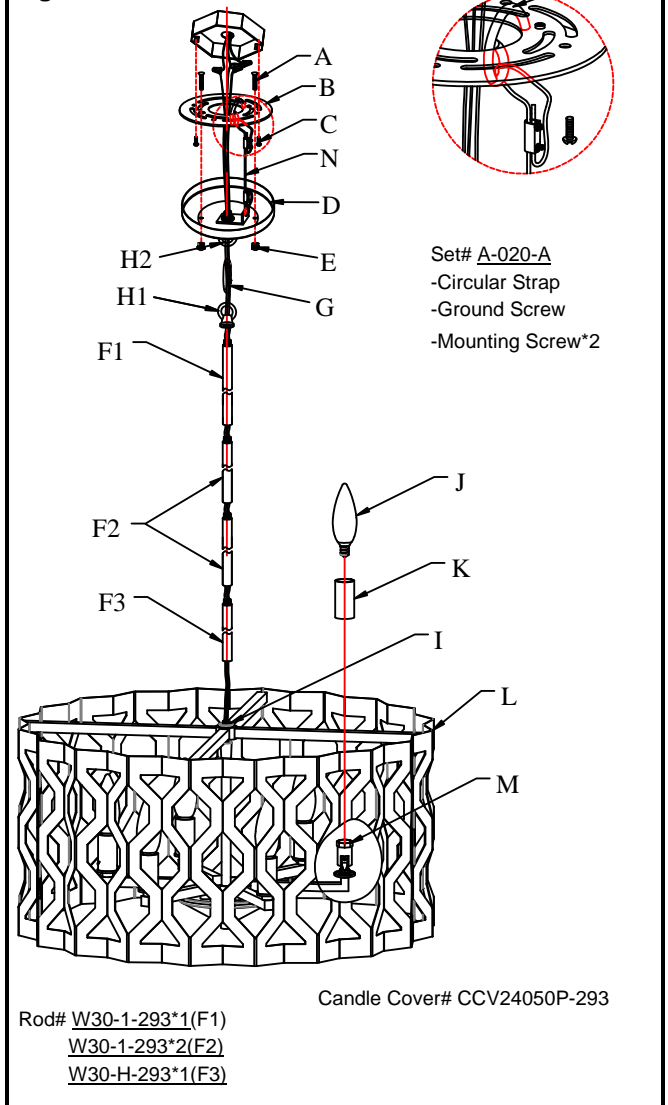
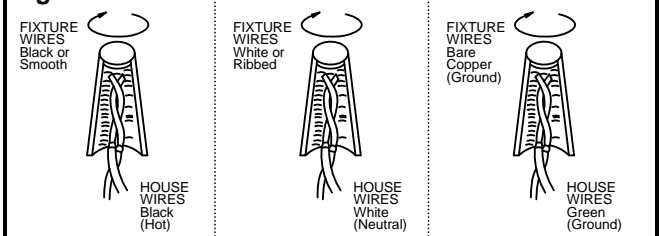
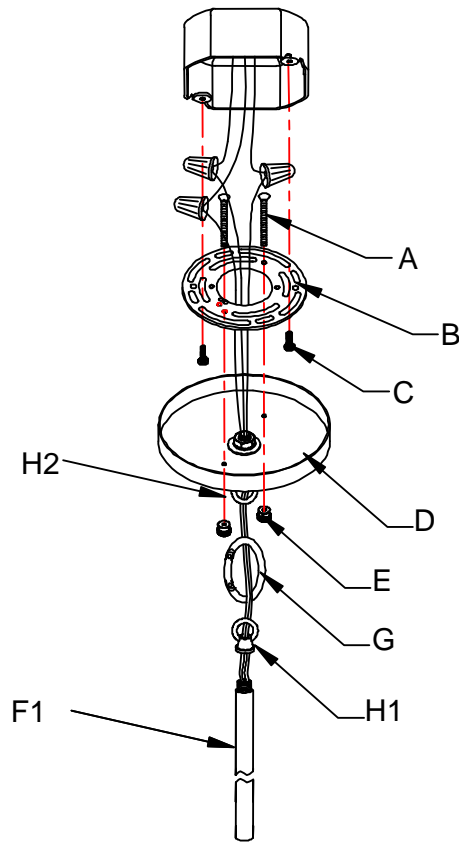

Fig. 3



LA-2743E

Fig.2



a. Hardware Bag:

- A. Screw*2
- B. Circular Strap*1
- D. Canopy *1
- C. Mounting Screw*2
- E. Knurled Knob*2
- H. Loop*2
- G. Quick Link*1

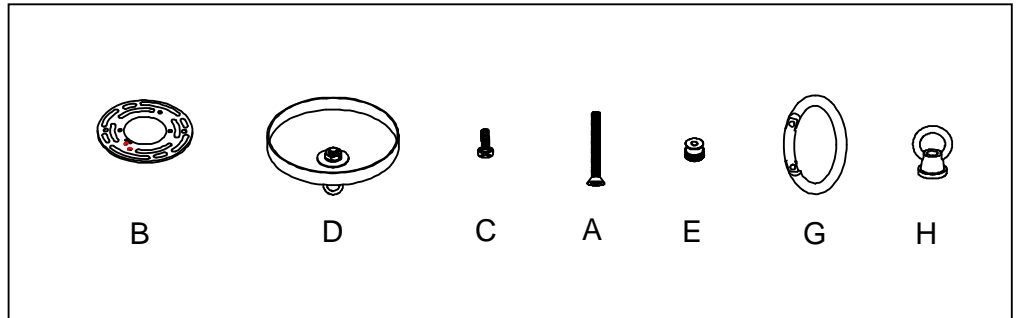

b. Hardware Bag:

- F1. ROD 12"*1
- F2. ROD 12"*2
- F3. ROD 6"*1

