

INSTALLATION INSTRUCTIONS

Item#3003-77 (New. 03/15/2017)

READ AND SAVE THESE INSTRUCTIONS

WARNING! SHUT POWER OFF AT FUSE OR CIRCUIT BREAKER.

AVERTISSEMENT! COUPER LE COURANT AU NIVEAU DES FUSIBLES OU DU DISJONCTEUR.

MOUNTING THE FIXTURE (Fig.1)

1. Shut off the power at the circuit breaker and remove old fixture, including the mounting hardware.
2. Carefully remove the fixture from the carton and check that all parts are included as shown in the illustration.
3. Attach mounting plate (B) to the outlet box (A) (not included) with mounting screws (C) (size: #8-32N*L0.5"). The side of the mounting plate Marked "GND" must face out.

CONNECTING THE WIRES (Fig. 2)

4. At this point, connect the electrical wires as shown in Fig. 2, making sure that all wire connectors are secured. If your outlet box has a ground wire (green or bare copper), connect the fixture's ground wire to it. Otherwise, connect the fixture's ground wire directly to the mounting plate using the green screw provided. After wires are connected, tuck them carefully inside the junction box.

FINISHING THE INSTALLATION (Fig.1)

5. Place fixture body (D) over mounting plate (B), and secure with screws (E).
6. Place the glass shade (F) followed by metal ring (G) over the socket, fasten with screw shell (H) by using the tool (I).
7. Install the light bulb (not included) in accordance with the fixture's specifications. **(DO NOT EXCEED THE MAXIMUM WATTAGE RATING!) (NE PAS DEPASSER LA PUISSANCE NOMINALE MAXIMALE!)**

Your installation is now complete. Return power and test the fixture.

Note: Illustration (Fig.1) on this manual is for installation purposes only. It may or may not be identical to the fixture purchased.

Fig. 1

Set#A-020-102107
-Mounting Plate
-Ground screw
-Mounting Screw*2

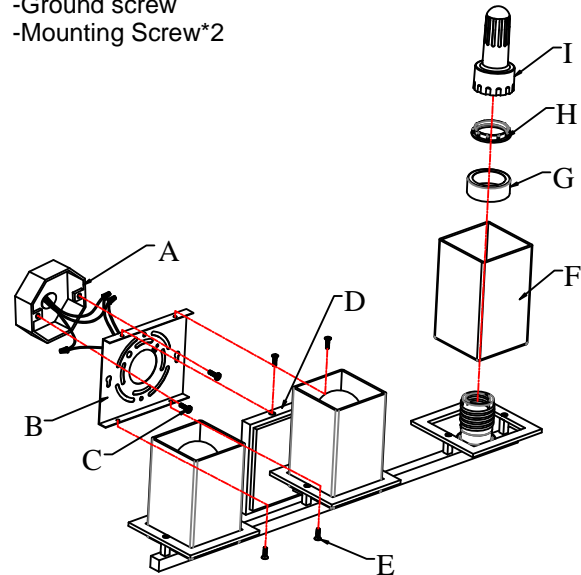

Socket ring # SKT-RING-26
E26 Socket Spanner: WRH-1-51

Fig. 2

