

Please go to www. quoizel. com for product cleaning tips. Go to the **Care + Maintenance** selection.

Tools Required: Flathead screwdriver, Phillips screwdriver, pliers, wire cutters, wire strippers, electrical tape, safety glasses.

Integrated 22W LED

Estimated Assembly Time: 20-30 minutes

Preparation: Identify and inspect all parts before beginning installation. Check package content list and diagrams below to be sure all parts are present. If any parts are missing or damaged, do not attempt to assemble, install, or operate the fixture. Contact customer service for replacement parts.

⚠ Warnings and Cautions

Turn off electricity at circuit breaker or main fuse box before installation. Consult a licensed electrician if in doubt.

These instructions are provided for your safety. It is very important you read them completely before installing the fixture. We strongly recommend that a licensed, professional electrician perform the installation.

Disconnect fixture from power source before replacing bulbs. Make sure bulbs are given sufficient time to cool before removal.

Package Contents

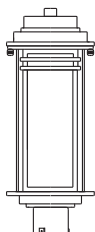

B Fixture Body x 1

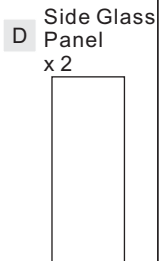
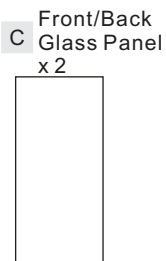

STEP 1 – Install Glass

- Unscrew the Mounting Screw, remove the Fixture Hood from the Fixture Body (B).
- Insert Glass Panels (D/C) into slots in the bottom edge of the Cage. Fold Tabs on the top edge of the Cage to secure Glass Panels.
- Attach the Cage with Glass Panels back onto fixture hood and secure by threading the Mounting Ball onto the Bolts. Hand tighten until snug.

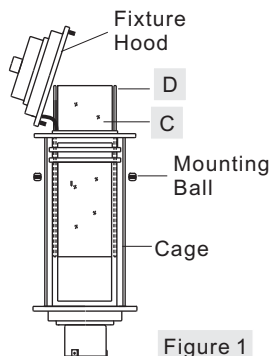
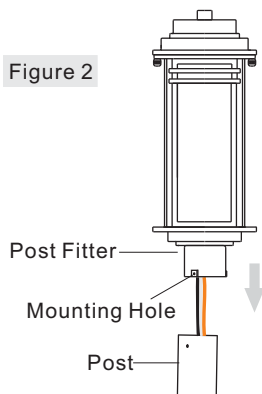

Figure 1

STEP 2 – Drill Pilot Holes on Post

- Carefully fit the Post Fitter over the end of the Post (not supplied), making sure the Post Fitter is fully seated.
- Mark the drill point for the (3) Mounting Screws, using (3) Mounting Holes as reference. After marking hole locations, remove fixture from post and drill 1/16" pilot holes for screws.

Figure 2



STEP 3 - Wire Connections

- Use standard wire connectors (not included) to make all wire connections. (Connectors are not included with fixture.) Twist connectors until wires are tightly joined together. Wrap each connection with approved electrical tape and carefully stuff all the connected wires into the Outlet Box.

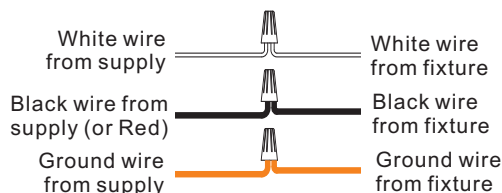

Figure 3

STEP 4 – Attach Fixture Body to Post

- Coat the top 1" of the Post with Clear Silicone Caulk (not supplied) and position the Post Fitter onto the Post. Be sure to seat it completely, aligning the holes in the Fitter with the 1/16" Pilot Holes drilled into the Post.
- Secure the Fixture to Post with (3) Mounting Screws (A).

Your fixture is now assembled and ready to use. Enjoy!

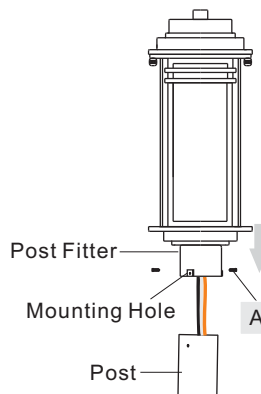

Figure 4

Thank you for purchasing a Quoizel product.
Need assistance with parts or assembly? Call Quoizel customer service at 1-800-645-3184
or visit us on-line at www. quoizel. com

BEC9009SBK

FINISH: STONE BLACK



NOTE: ALL DIMENSIONS ARE ROUNDED UP TO THE NEAREST 1/4"

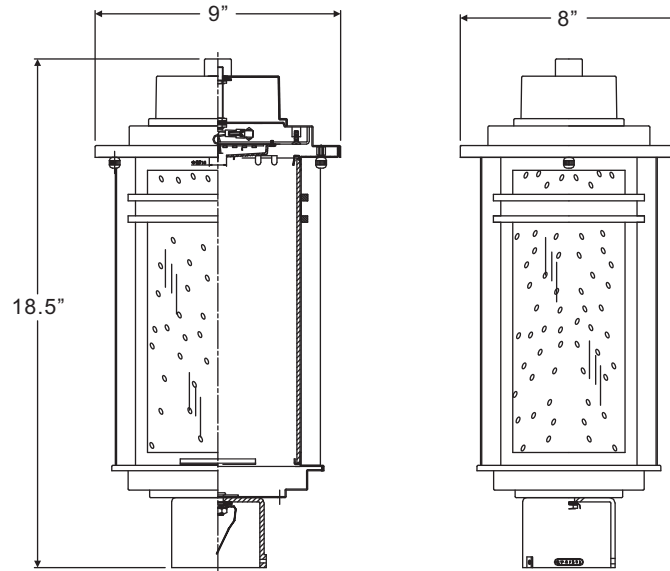

Thank you for purchasing a Quoizel product.
Need assistance with parts or assembly? Call Quoizel customer service at 1-800-645-3184
or visit us on-line at www.quoizel.com