

Please go to www.quoizel.com for product cleaning tips. Go to the **Care + Maintenance** selection.

Tools Required: Flathead screwdriver, Phillips screwdriver, pliers, wire cutters, wire strippers, electrical tape, safety glasses.
Integrated 14W LED

Estimated Assembly Time: 20-30 minutes

Preparation: Identify and inspect all parts before beginning installation. Check package content list and diagrams below to be sure all parts are present. If any parts are missing or damaged, do not attempt to assemble, install, or operate the fixture. Contact customer service for replacement parts.

⚠ Warnings and Cautions

Turn off electricity at circuit breaker or main fuse box before installation. Consult a licensed electrician if in doubt.

These instructions are provided for your safety. It is very important you read them completely before installing the fixture. We strongly recommend that a licensed, professional electrician perform the installation.

Disconnect fixture from power source before replacing bulbs. Make sure bulbs are given sufficient time to cool before removal. Do not subject glass parts to any shock while in operation or shattering may result.

Package Contents

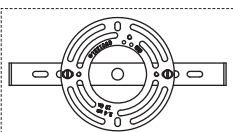

A Crossbar Assembly
x 1

B Mounting Screw
x 2

C Wall Anchor
x 2

D Self-tapping Screw
x 2

E Washer
x 2

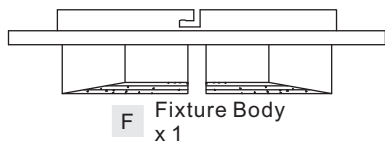

F Fixture Body
x 1

STEP 3 – Attach Fixture Body to Crossbar

A. Fit excess cord and electrical wires in the ceiling canopy of the Fixture Body (F) properly. Attach the Fixture Body (F) over the Crossbar Assembly (A) and line up the hole on the side of the ceiling canopy to the mounting holes on the ends of flat strap. Secure with the Mounting Screws (B) and hand tighten until snug.

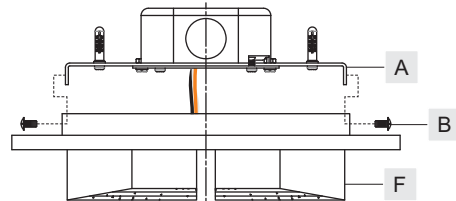

Figure 3

STEP 1 – Attach Crossbar Assembly to Outlet Box

A. Attach the Crossbar Assembly (A) onto the Outlet Box and make two marks on the ceiling from keyholes on the flat strap of the Crossbar Assembly (A).

B. Remove the Crossbar Assembly (A) and drill proper holes on the ceiling from marks. Insert Wall Anchors (C) into the holes properly. Attach the Crossbar Assembly (A) to Outlet Box. Thread Outlet Box Screws (not Supplied) into mounting holes on the Outlet Box. Pass Washers (E) over Self-tapping Screws (D) and thread Self-tapping Screws (D) into Wall Anchors (C). Hand tighten until snug.

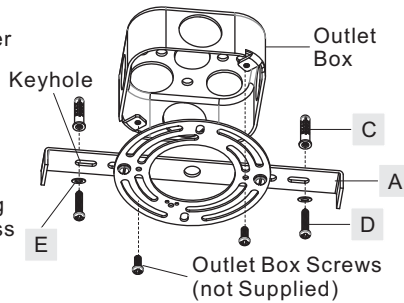

Figure 1

STEP 2 - Wire Connections

A. Use standard wire connectors (not included) to make all wire connections. (Connectors are not included with fixture.) Twist connectors until wires are tightly joined together. Wrap each connection with approved electrical tape and carefully stuff all the connected wires between Crossbar Assembly (A) and Fixture Body (F).

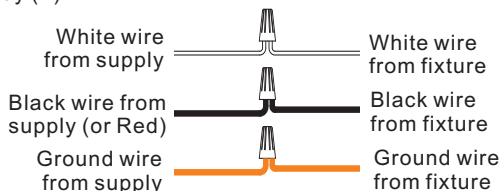
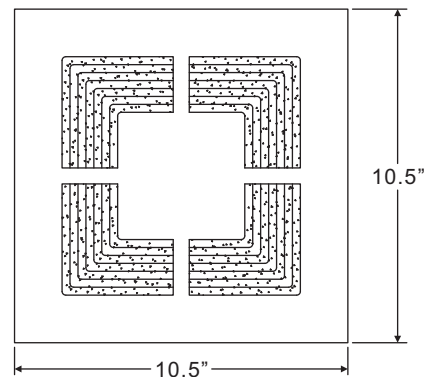
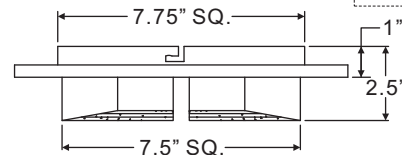
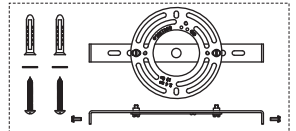

Figure 2

PCLT1611C

FINISH: POLISHED CHROME



NOTE: ALL DIMENSIONS ARE ROUNDED UP TO THE NEAREST 1/4"

NO.	PART NUMBER	REPLACEMENT PART	QTY.
1			

Thank you for purchasing a Quoizel product.
Need assistance with parts or assembly? Call Quoizel customer service at 1-631-273-2700
or visit us on-line at www.quoizel.com